

FUJIFILM
Value from Innovation



NEW
FCT Speedia **HD**

Great Potential with Compact Body — FCT Speedia HD for you

Compact & High Performance CT

In the modern healthcare environment the demand towards CT goes beyond simple high throughput and accurate diagnosis. Efficient operator workflow, improved patient experience and easy installation into existing facilities are also main considerations. The Speedia HD offers high level solutions without compromise.

FCT Speedia HD



High diagnostic image in a single breath hold

MPR as a routine examination with high speed sub-millimeter scanning

Speedia HD enables high-speed whole-body scanning with sub-millimeter slices, which is difficult to achieve on 16 slice CT systems. A single breath hold (approx 14sec.), can produce high-resolution images in the range of 1100mm or more. Thereby allowing wide range, high resolution MPR images to be acquired as routine.

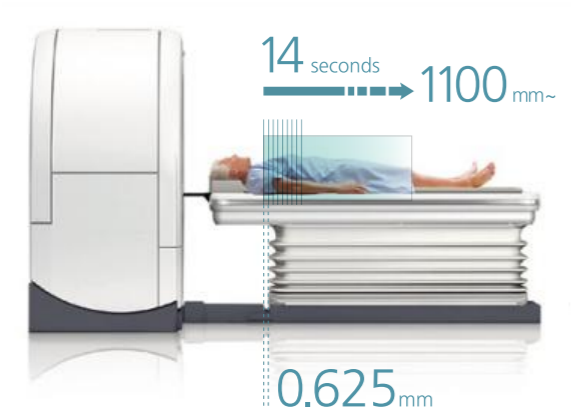

Wide-range MPR

Chest scan at 4.5sec. Thoraco-abdominal scan at 7.5sec. High Speed Scanning with greater care for the Patient

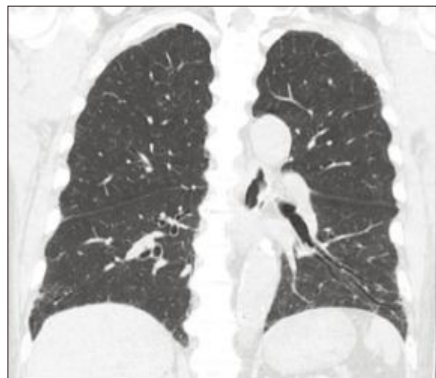

MPR

Speedia HD with its 40mm width detector and unique 3D reconstruction algorithm-CORE method, achieves the high-speed scan even when using a pitch of 1.58. Therefore, it enables a chest area of 320mm to be scanned in only 4.5sec and a thoraco-abdominal area of 570mm in just 7.5sec. This reduces the burden on the patients who have difficulty maintaining a still position or holding a breath for a long-time.

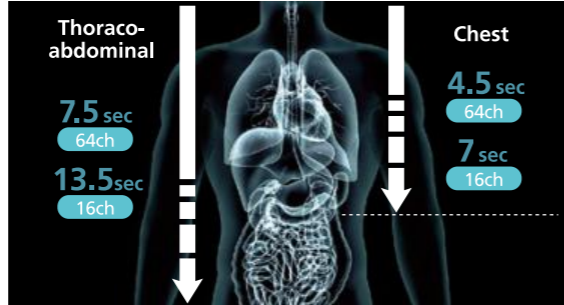

Extends the potential of your service, without redundancy



High-pitch scan

CORE satisfies both of High-Speed Scan and High Image Quality

CORE (Cone-beam Reconstruction) method which is a unique 3D reconstruction algorithm optimizes the range of acquisition data to be reconstructed. By utilizing the data across the whole detector effectively, a high quality image with less artifact can be obtained even with a high-pitch scan.

Smart Dose Management using the Latest Technology

1 IntelliEC

Automatic 3D mA modulation for dose optimization

The tube current is optimized in a 3D direction (X-Y-Z) based on information on the size of the patient obtained from the scanogram and preset target SD. This allows the production of images at a constant noise level, over the entire scan region optimizing the balance between image quality and exposure.

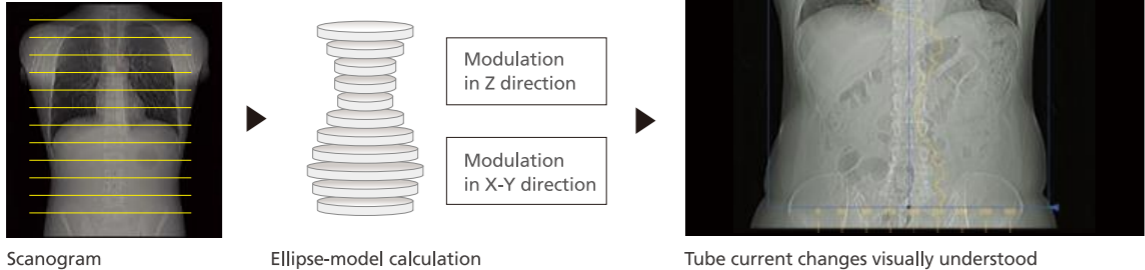

2 Intelli IP Iterative processing for noise reduction

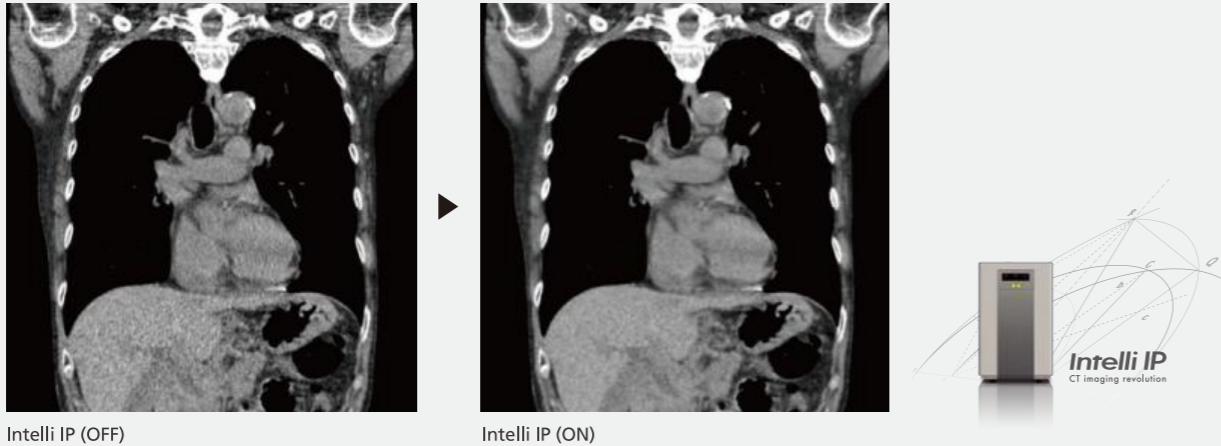

Advanced noise reduction processing employing iterative reconstruction technology reduces image noise and artifacts while maintaining a high quality image at lower doses. 7 levels of dose reduction can be selected to optimize dose and image quality per examination.

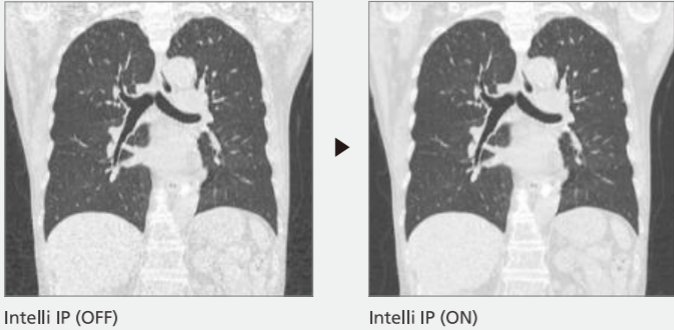

3 500mm Full FOV Data Acquisition

Reducing the need for re-scan

The Speedia HD acquires and retains full FOV data (500mm) for every scan. Therefore in cases where the patient body area is outside of the FOV set before the scan, the lost portion can be recovered not by re-scan but by re-calculation (if the portion is within the maximum FOV).

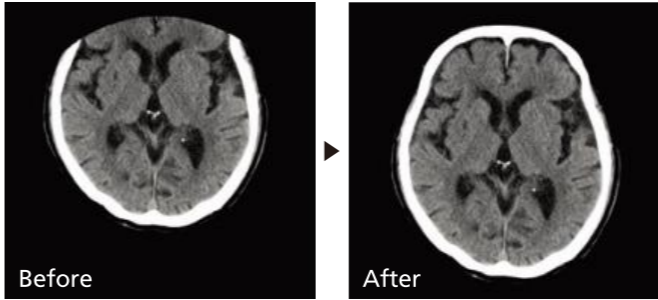

Re-calculation

4 Motion Correction

Dedicated processing makes it possible to reduce the motion artifact for the patient who has difficulty in remaining still during the scan, reducing the need for re-scan.



Dose Information Display and distribution

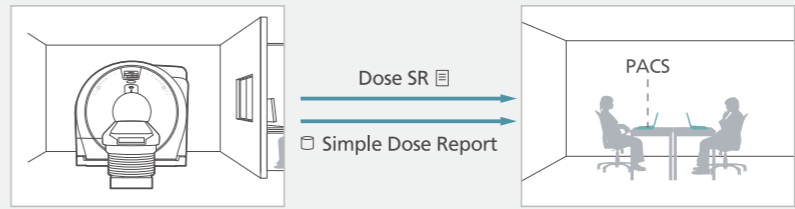

Managing the patients dose information and its transfer to the connected PACS system efficiently has become of high importance. Simple Dose Report can save the data as secondary capture and send to PACS. DICOM Dose SR sends the dose information to PACS as a structured report.

Supporting an Efficient Workflow and use of Existing Facilities



Operator-friendly

24-inch wide monitor clearly displays all the information in one view. Controller is attached to the keyboard. More compact operating environment than a 2 monitor console.

An operator-friendly GUI delivers the latest design CT system. Intuitive and easier operation with Quick-Entry mode enables simple operation for all users with fewer buttons and larger icons.

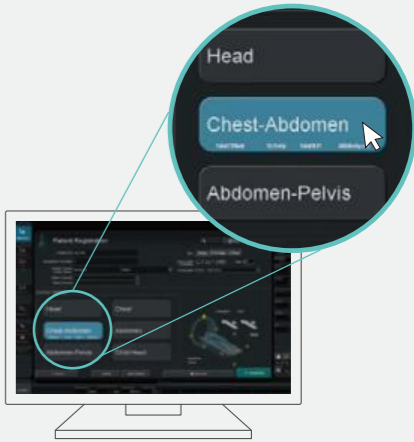

Simple Siting

By utilizing only 3 main system modules*; gantry, patient table, and operation console. The Speedia HD achieves an impressive compact footprint.

(* System transformer may be required depending on country.)

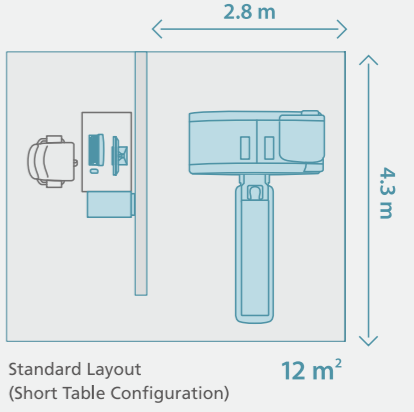
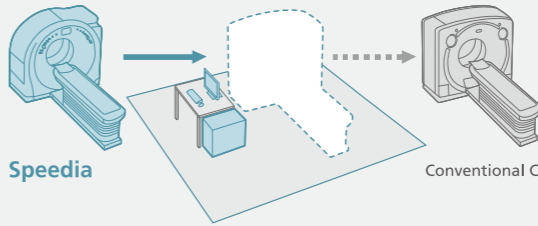

Open & Compact

A class leading bore size to reduce patient anxiety, while maintaining a compact foot print to improve installation into existing rooms.

750 mm wide bore

500 mm full FOV

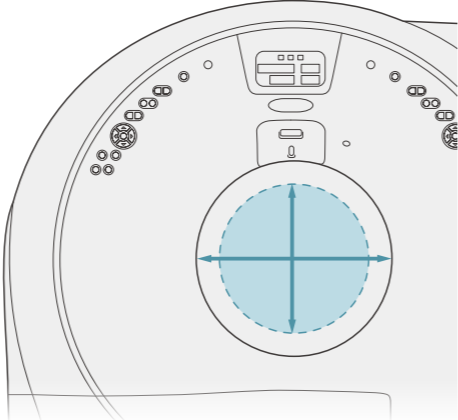

SYNAPSE[®] 3D

Experience Advanced clinical workstation.

SYNAPSE 3D, uses unique image recognition technologies to automatically extract organs and vessels. The technology enables automatic extraction of lung, lung lobes the bronchus, liver, portal vein and hepatic vein extraction. This feature makes possible a large variety of 3D analysis, such as visualization of chronic respiratory disease and Liver and Kidney preoperative simulations.

Image recognition



Applies Fujifilm image analyze technique which used on FUJIFILM digital camera

High quality images



Stress-free operation



Application Expanding SYNAPSE 3D Clinical analysis

• Smart tracking

Based on the previously stored information, the areas recognized as blood vessels are extracted.

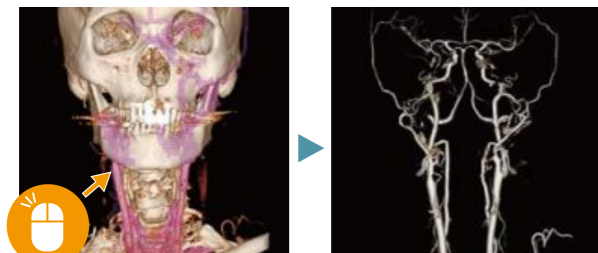

One-click operation to extract the areas that touches bones

• Vessels

Vessels are extracted with one click by using image recognition technology

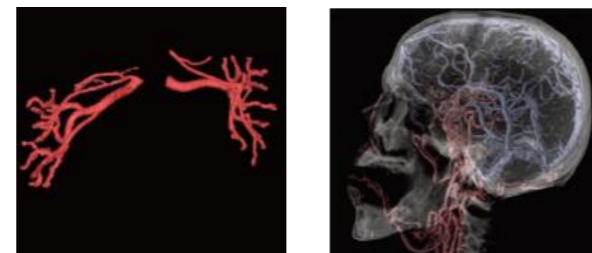

General CPR

Cerebral Arteries and Vein separation

• Bone removal

Bones are extracted or removed with one click based on the CT value and the shape of the region of interest recognized by the FUJIFILM Algorithm technology.



Skull removal

Lower extremity bones removal

• Non-rigid registration

Non-rigid registration enables SYNAPSE 3D to move an organs in images acquired at different phases, and different time points to be corrected.

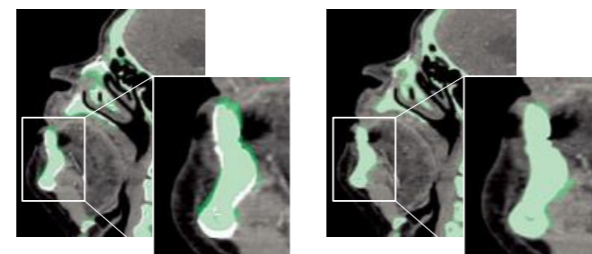

Rigid Registration

Non-rigid Registration

• Organs

Image Intelligence™ makes it happen to extract organs and simplify your work.

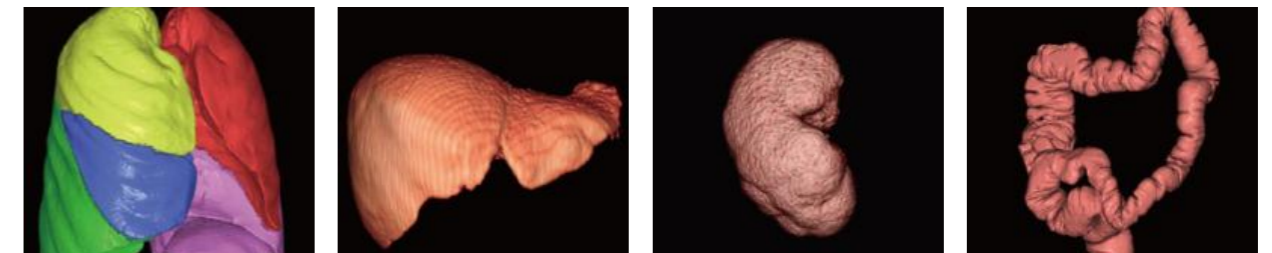

Lung lobe

Liver

Kidney

Colon



Lung Analysis



Virtual Endoscope

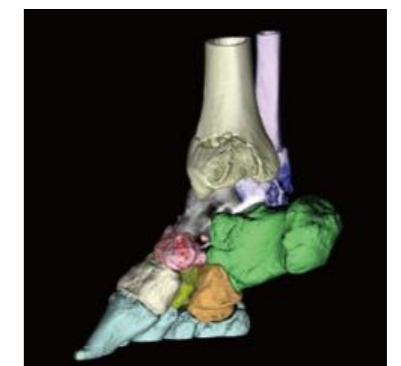

Orthopedics

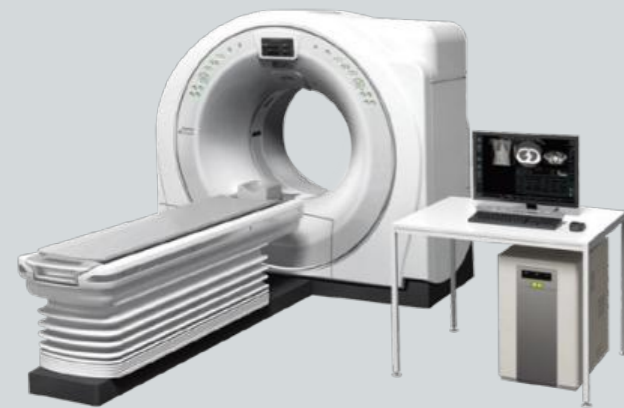
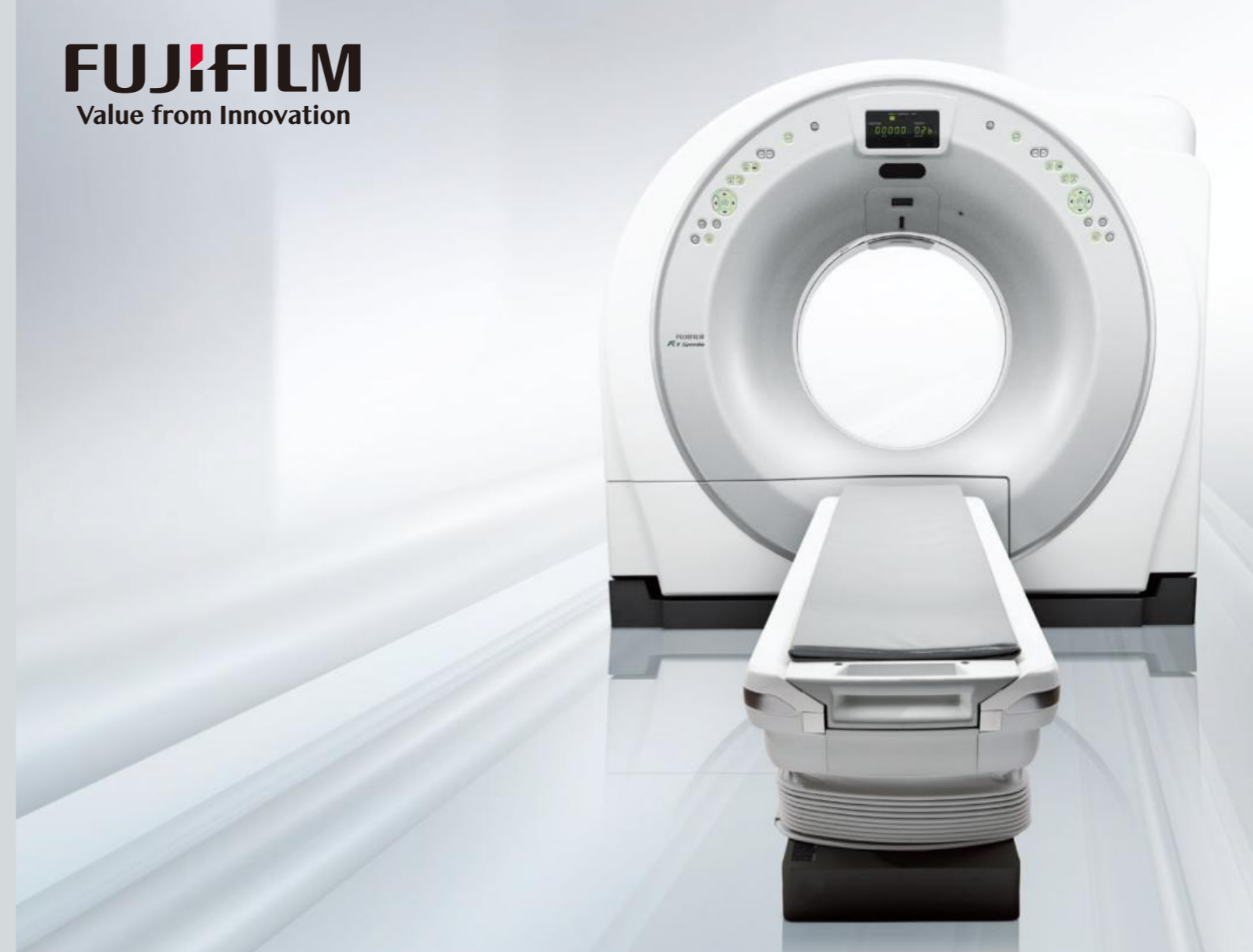

Specification

Number of Slice	64 slice (Standard) / 128 slice (Optional)	Standard software	Intelli IP (Iterative processing for noise reduction), IntelliEC (Automatic exposure control), Predict Scan (Contrast medium monitoring), CEV-CPR (Blood vessel analysis software), DICOM 3.0 Image transfer, DICOM Print, Simple Dose Report, DICOM Dose SR
Detector	0.625mm X 64rows	Power supply voltage	3-phase 380 / 400 / 415 / 440 VAC
Scan time	0.75~ 2sec	Power supply capacity	75kVA
Slice thickness	0.625mm (min.)		
Bore diameter	750mmφ		
X-ray tube capacity	5MHU		
X-ray tube voltage	80, 100, 120, 140kV		
X-ray tube current	10~400mA		

Specification are subject to change without notice. All brand names or trademarks are the property of their respective owner.

The model type of FCT Speedia HD is Supria. For the details of regulatory information and availability in your country, please contact our local representative. All products require the regulatory approval of the importing country.

NEW
FCT Speedia HD

